

# PLT5 520

## Metal Can® TO56

Green Laser Diode in TO56 Package



### Applications

- Health Monitoring (Heart Rate Monitoring, Pulse Oximetry)
- Measurement Levelling
- Projection Home LED & Laser
- Projection Professional LED & Laser
- Stage Lighting (LED & Laser)

### Features:

- Optical output power (continuous wave): 30 / 50 mW ( $T_c = 25^\circ\text{C}$ )
- Typical emission wavelength: 520 nm
- Efficient radiation source for cw and pulsed operation
- Single mode semiconductor laser
- High modulation bandwidth
- TO56 package with photo diode

### Ordering Information

Type	Peak output power typ. $P_{opt}$	Ordering Code
PLT5 520_B1-3	50 mW	Q65111A5771
PLT5 520_B1-6	30 mW	Q65111A6145

## Maximum Ratings

 $T_{\text{case}} = 25\text{ °C}$ 

Parameter	Symbol		Values
Operating temperature	$T_{\text{op}}$	min.	-20 °C
		max.	60 °C
Storage temperature	$T_{\text{stg}}$	min.	-40 °C
		max.	85 °C
Junction temperature	$T_{\text{j}}$	max.	150 °C
Forward current <sup>1)</sup>	$I_{\text{F}}$	max.	200 mA
Reverse voltage <sup>2)</sup>	$V_{\text{R}}$	max.	2 V
Soldering temperature	$T_{\text{S}}$	max.	260 °C

 $t_{\text{max}} = 10\text{ s}$ 

Operation outside these conditions may damage the device. Operation at the maximum ratings influences lifetime.

## Characteristics

$P_{\text{opt}} = 50 \text{ mW}$  (B1 - B3),  $P_{\text{opt}} = 30 \text{ mW}$  (B4 - B6);  $T_{\text{case}} = 25 \text{ °C}$

Parameter	Symbol		Values
Operating current <sup>1)</sup> B1 - B3	$I_{\text{op}}$	typ.	115 mA
		max.	140 mA
Operating current <sup>1)</sup> B4 - B6	$I_{\text{op}}$	typ.	95 mA
		max.	120 mA
Operating voltage <sup>3)</sup> B1 - B3	$V_{\text{op}}$	typ.	6.0 V
		max.	6.9 V
Peak wavelength <sup>4)5)</sup>	$\lambda_{\text{peak}}$	min.	510 nm
		typ.	520 nm
		max.	530 nm
Spectral bandwidth (FWHM)	$\Delta\lambda$	typ.	1 nm
Beam divergence (FWHM) parallel to pn-junction	$\Theta_{\parallel}$	min.	6 °
		typ.	8 °
		max.	10 °
Beam divergence (FWHM) perpendicular to pn-junction	$\Theta_{\perp}$	min.	19 °
		typ.	22 °
		max.	25 °
Threshold current B1 - B3	$I_{\text{th}}$	typ.	30 mA
		max.	65 mA
Threshold current B4 - B6	$I_{\text{th}}$	typ.	40 mA
		max.	65 mA
Forward voltage <sup>3)6)</sup> B4 - B6	$V_{\text{F}}$	typ.	5.8 V
		max.	6.7 V
TE polarization	$P_{\text{TE}}$	typ.	100:1
Modulation frequency	$f$	min.	100 MHz
Monitor current <sup>7)8)</sup>	$I_{\text{m}}$	typ.	90 $\mu\text{A}$
Thermal resistance junction case real	$R_{\text{thJC}}$	typ.	34 K / W

Info: according to OS-PCN-2021-007-A

## Wavelength Groups

Group	Peak wavelength <sup>4)</sup> min. $\lambda_{\text{peak}}$	Peak wavelength <sup>4)</sup> max. $\lambda_{\text{peak}}$
B1	510 nm	515 nm
B4	510 nm	515 nm
B2	515 nm	520 nm
B5	515 nm	520 nm
B3	520 nm	530 nm
B6	520 nm	530 nm

### Relative Spectral Emission 9), 10)

$$P_{\text{opt}} = f(\lambda); \text{ Group (B2; B5)}$$

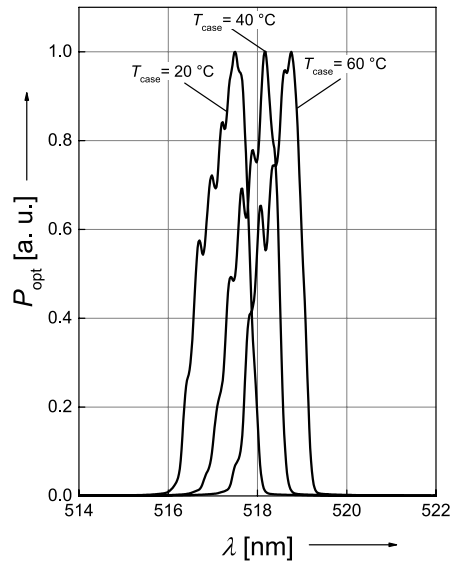

### Beam Divergence 9), 10)

$$P_{\text{opt}} = f(\Theta)$$

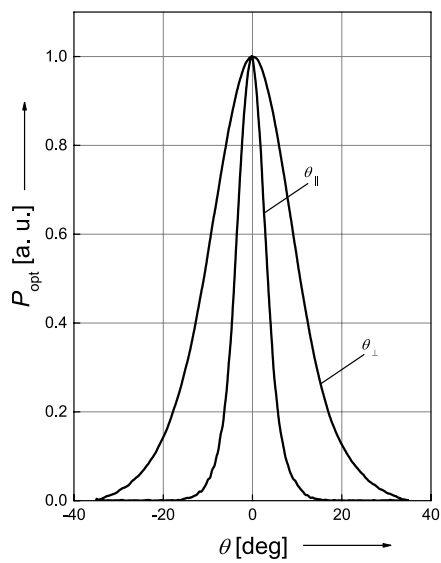

**Optical Output Power** 9), 10)

B1 - B3:  $P_{opt} = f(I_F)$

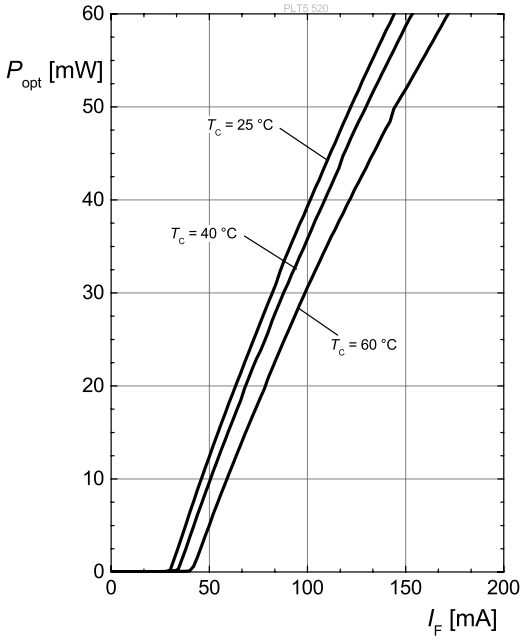

**Optical Output Power** 9), 10)

B4 - B6:  $P_{opt} = f(I_F)$

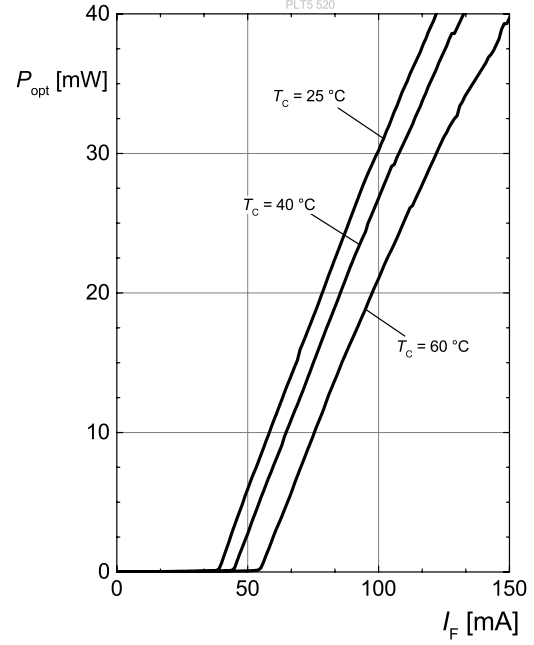

**Opt. Power / Forward Voltage** 9), 10)

B1 - B3:  $V_F = f(I_F)$

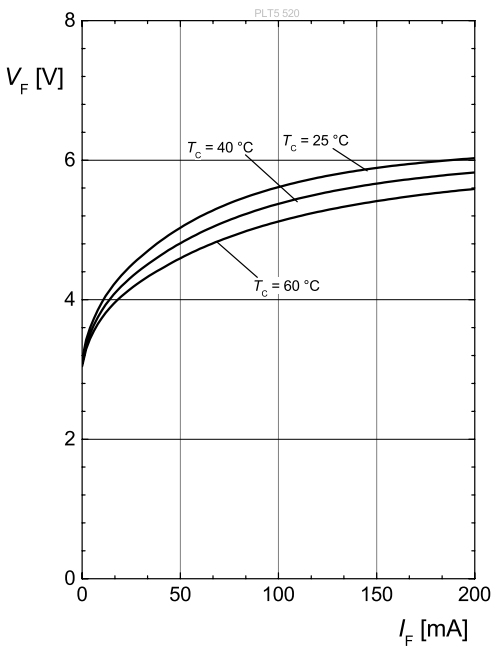

**Opt. Power / Forward Voltage** 9), 10)

B4 - B6:  $V_F = f(I_F)$

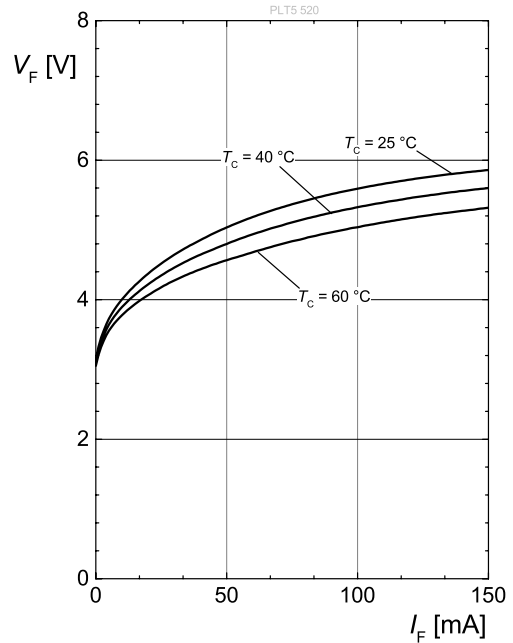

## Threshold Current

$$I_{th} = f(T_C)$$

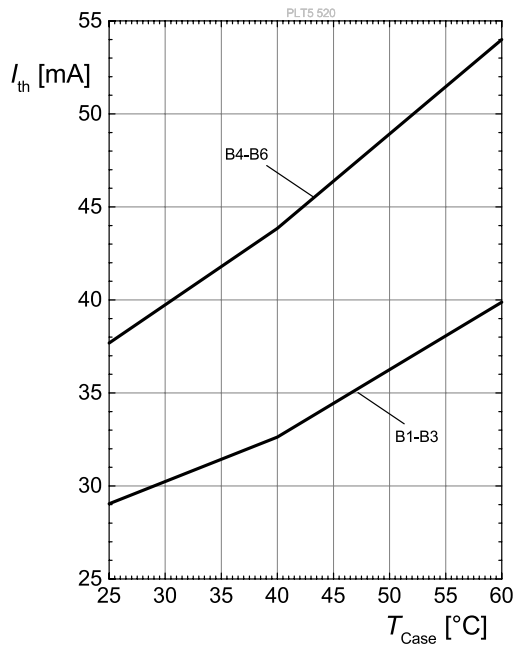

## Max. Permissible Forward Current

$$I_{F,max} = f(T_A)$$

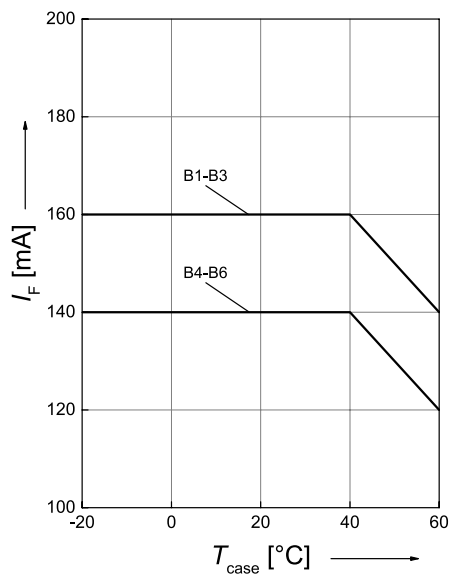

## Dimensional Drawing <sup>11)</sup>

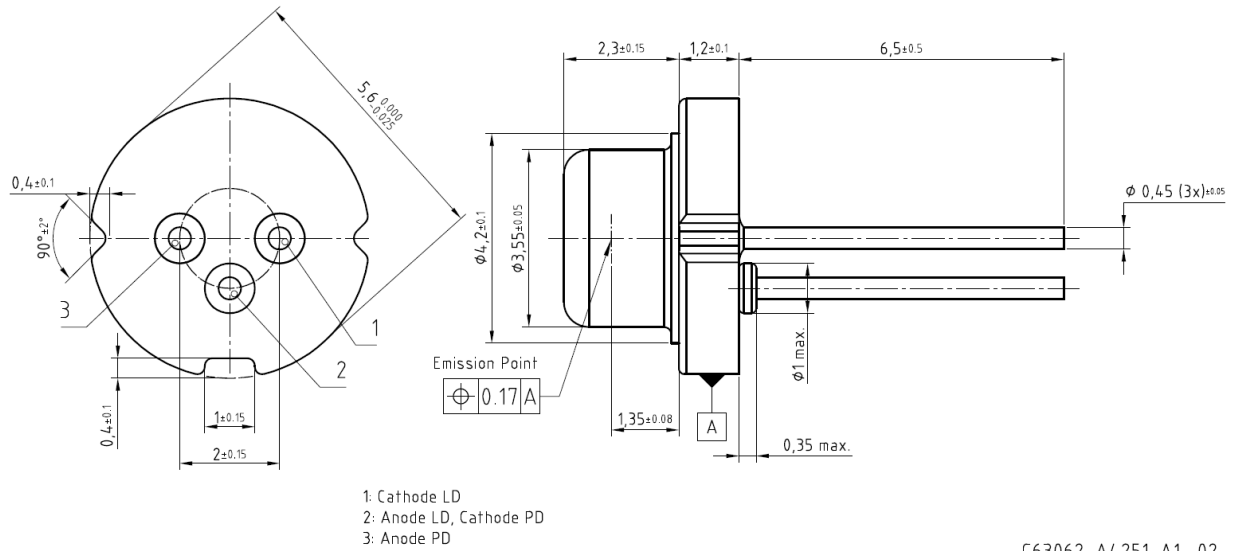

C63062-A4251-A1 -02

## Further Information:

**Approximate Weight:** 310.0 mg

**ESD advice:** ATTENTION – Observe Precautions For Handling – Electrostatic Sensitive Device



## Electrical Internal Circuit

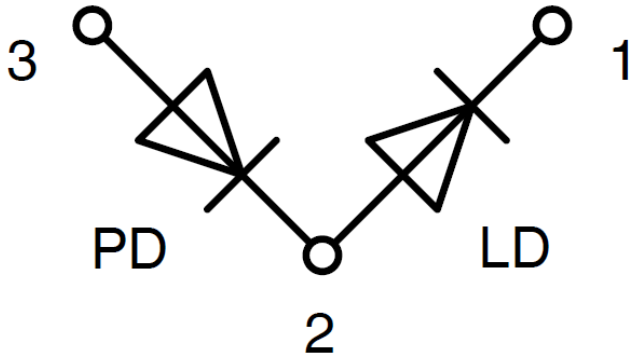

Pin	Description
PIN 1	LD Cathode
PIN 2	LD Anode, PD Cathode (case)
PIN 3	PD Anode

PLT5 520

Tray <sup>11)</sup>

200 pieces per Tray

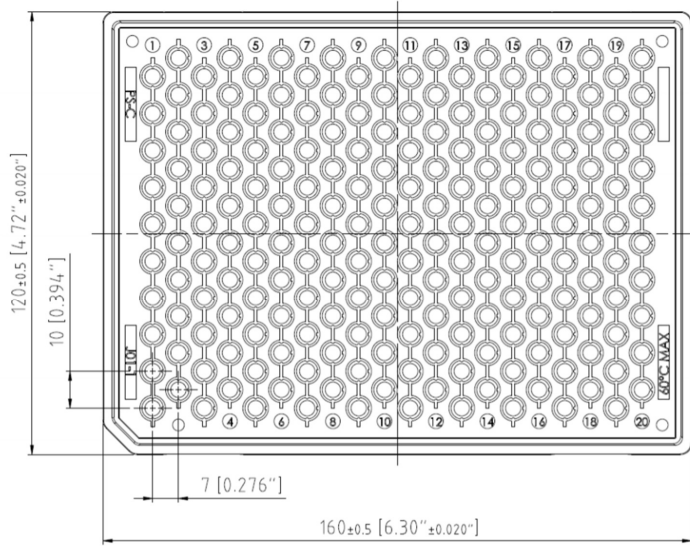

C63062-A4337-B1

Tray <sup>11)</sup>

100 pieces per Tray

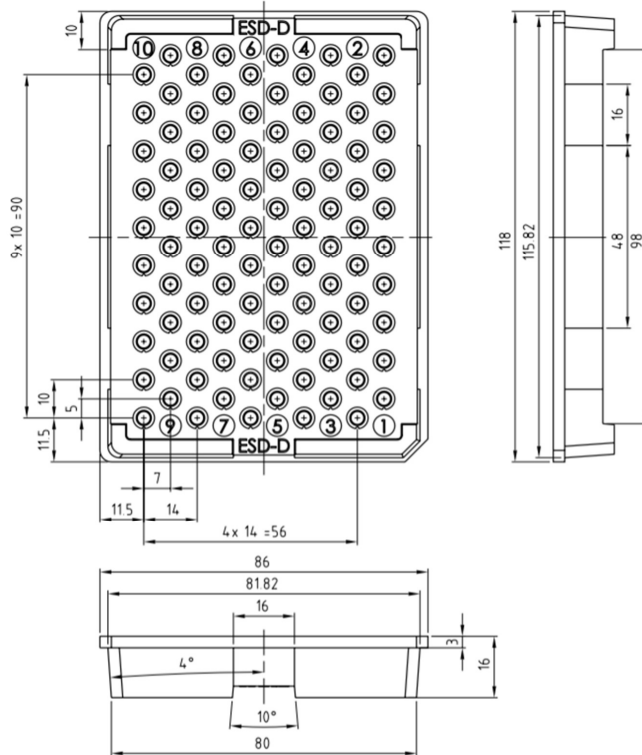

C63062-A4404-X1-01

### Barcode-Product-Label (BPL)

**OSRAM Opto Semiconductors** LX XXXX BIN1: XX-XX-X-XXX-X

RoHS Compliant

(6P) BATCH NO: 1234567890

(1T) LOT NO: 1234567890 (9D) D/C: 1234

(X) PROD NO: 123456789 (Q) QTY: 9999 (G) GROUP: XX-XX-X-X

ML Temp ST  
X XXX °C X

Pack: RXX  
DEMY XXX  
X\_X123\_1234.1234 X



The diagram shows a rectangular label with rounded corners. It contains the OSRAM logo and company name at the top left. To the right are fields for 'LX XXXX' and 'BIN1: XX-XX-X-XXX-X'. Below the logo is the text 'RoHS Compliant'. The label features three horizontal barcode areas. The first is labeled '(6P) BATCH NO: 1234567890'. The second is labeled '(1T) LOT NO: 1234567890' and '(9D) D/C: 1234'. The third is labeled '(X) PROD NO: 123456789 (Q) QTY: 9999 (G) GROUP: XX-XX-X-X'. To the right of the second barcode is a circular icon with a diagonal line and three raindrops, with the text 'ML Temp ST X XXX °C X' next to it. Below this icon is the text 'Pack: RXX', 'DEMY XXX', and 'X\_X123\_1234.1234 X'. A square QR code is located on the right side of the label.

OHA04563

### Schematic Transportation Box <sup>11)</sup>

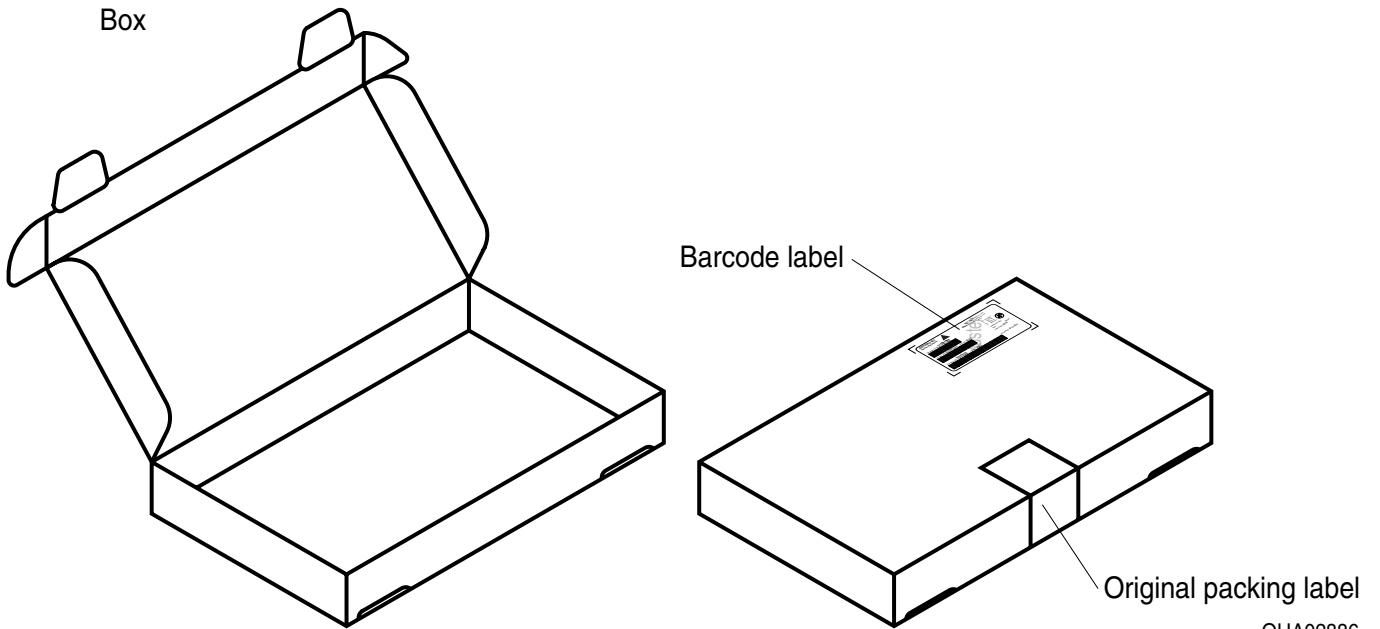

OHA02886

### Dimensions of Transportation Box

At pieces per Tray	Width	Length	Height
200	170 ± 5 mm	270 ± 5 mm	45 ± 5 mm
100	103 ± 5 mm	128 ± 5 mm	25 ± 5 mm

## Notes

Depending on the mode of operation, these devices emit highly concentrated visible and non visible light which can be hazardous to the human eye. Products which incorporate these devices have to follow the safety precautions given in IEC 60825-1.

Subcomponents of this device contain, in addition to other substances, metal filled materials including silver. Metal filled materials can be affected by environments that contain traces of aggressive substances. Therefore, we recommend that customers minimize device exposure to aggressive substances during storage, production, and use. Devices that showed visible discoloration when tested using the described tests above did show no performance deviations within failure limits during the stated test duration. Respective failure limits are described in the IEC60810.

### Important notes of operation for laser diode

#### a) Electrical operation

OSRAMs laser diodes are designed for maximum performance and reliability. Operating the laser diode above the maximum rating even for very short periods of time can damage the laser diode or reduce its lifetime. The laser diode must be operated with a suitable power supply with minimized electrical noise. The laser diode is very sensitive to electrostatic discharge (ESD). Proper precautions must be taken.

#### b) Mounting instructions

In order to maintain the lifetime of the laser diode proper heat management is essential. Due to the design of the laser diode heat is dissipated only through the base plate of the diode's body. A proper heat conducting interconnection between the diodes base plate and the heat sink must be maintained.

For further application related information please visit [www.osram-os.com/appnotes](http://www.osram-os.com/appnotes)

## Disclaimer

### **Attention please!**

The information describes the type of component and shall not be considered as assured characteristics. Terms of delivery and rights to change design reserved. Due to technical requirements components may contain dangerous substances.

For information on the types in question please contact our Sales Organization.

If printed or downloaded, please find the latest version on the OSRAM OS website.

### **Packing**

Please use the recycling operators known to you. We can also help you – get in touch with your nearest sales office. By agreement we will take packing material back, if it is sorted. You must bear the costs of transport. For packing material that is returned to us unsorted or which we are not obliged to accept, we shall have to invoice you for any costs incurred.

### **Product and functional safety devices/applications or medical devices/applications**

OSRAM OS components are not developed, constructed or tested for the application as safety relevant component or for the application in medical devices.

OSRAM OS products are not qualified at module and system level for such application.

In case buyer – or customer supplied by buyer – considers using OSRAM OS components in product safety devices/applications or medical devices/applications, buyer and/or customer has to inform the local sales partner of OSRAM OS immediately and OSRAM OS and buyer and /or customer will analyze and coordinate the customer-specific request between OSRAM OS and buyer and/or customer.

---

## Glossary

- 1) **Operating/Forward current:** IF is measured with an internal reproducibility of  $\pm 7\%$  (acc. to GUM with a coverage factor of  $k = 3$ ).
- 2) **Reverse Operation:** This product is intended to be operated applying a forward current within the specified range. Applying any continuous reverse bias or forward bias below the voltage range of light emission shall be avoided because it may cause migration which can change the electro-optical characteristics or damage the LED.
- 3) **Operating/Forward voltage:** VF is measured with an internal reproducibility of  $\pm 0.05\text{ V}$  (acc. to GUM with a coverage factor of  $k = 3$ ).
- 4) **Wavelength:** The wavelengths are measured with a tolerance of  $\pm 1\text{ nm}$ .
- 5) **Wavelength:**  $\lambda_{\text{peak}}$  is measured with an internal reproducibility of  $\pm 0.3\text{ nm}$  (acc. to GUM with a coverage factor of  $k = 3$ ).
- 6) **Forward Voltage:** The forward voltages are measured with a tolerance of  $\pm 0.1\text{ V}$ .
- 7) **Monitor current:** Monitor current refers to a reverse voltage of VRPD = 5 V. Monitor current is for short time power reference purpose only. Not guaranteed for accuracy.
- 8) **Monitor current:** For reference only.
- 9) **Typical Values:** Due to the special conditions of the manufacturing processes of semiconductor devices, the typical data or calculated correlations of technical parameters can only reflect statistical figures. These do not necessarily correspond to the actual parameters of each single product, which could differ from the typical data and calculated correlations or the typical characteristic line. If requested, e.g. because of technical improvements, these typ. data will be changed without any further notice.
- 10) **Testing temperature:** TA = 25°C (unless otherwise specified)
- 11) **Tolerance of Measure:** Unless otherwise noted in drawing, tolerances are specified with  $\pm 0.1$  and dimensions are specified in mm.

---

## Revision History

Version	Date	Change
1.1	2019-09-26	Description
1.2	2020-05-13	Characteristics
1.3	2020-05-18	Characteristics
1.4	2021-07-09	Maximum Ratings Tray Dimensions of Transportation Box

---



Published by OSRAM Opto Semiconductors GmbH EU RoHS and China RoHS compliant product  
Leibnizstraße 4, D-93055 Regensburg  
www.osram-os.com © All Rights Reserved.



此产品符合欧盟 RoHS 指令的要求；  
按照中国的相关法规和标准，不含有毒有害物质或元素。